

Plain/Slotted Unistrut Channel

- PL: Plain
- PG: Pre-Galvanized
- EG: Electro-Galvanized
- HDG: Hot Dip Galvanized
- SS: Stainless Steel

Dim. mm	Thickness mm
41x41	2.5
41x21	2.5
41x41	2.3
41x21	2.3
41x41	2.0
41x21	2.0
41x41	1.8
41x21	1.8
41x41	1.5
41x21	1.5
41x41	1.3
41x21	1.3
41x41	1.2
41x21	1.2

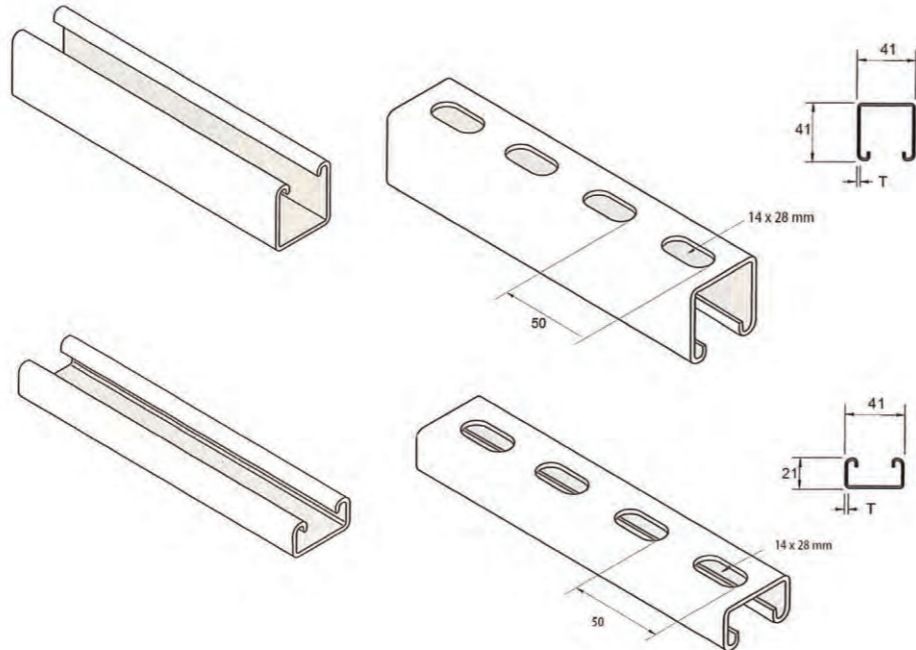

Standard lengths 10ft./3.0meter
Other length,thickness,hole size also available



All Thread Rods

- EG: Electro-Galvanized
- HDG: Hot Dip Galvanized
- SS: Stainless Steel



Standard lengths 10ft.3.0meter
Other length also available.

Cat.No.	Thread Size
TR-M6	M6
TR-M8	M8
TR-M10	M10
TR-M12	M12
TR-M14	M14
TR-M16	M16
TR-M18	M18
TR-M20	M20
TR-M22	M22

Channel Nuts

- EG: Electro-Galvanized
- HDG: Hot Dip Galvanized
- SS: Stainless Steel

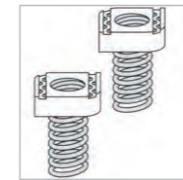

Channel Nut W/Regular Spring

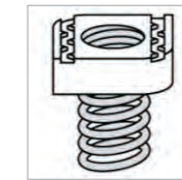

Channel Nut W/Short Spring

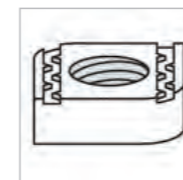

Channel Nut Without Spring

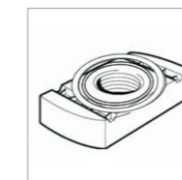

Top Grip Nut with Spring on Top

Thread Size	Nut Specification		Thickness mm
	Length mm	Width mm	
M6	34.5	19	6.0
M8	34.5	19	6.0/8.0
M10	34.5	19	8.0/9.2
M12	34.5	19	9.2/11.8
M14	34.5	30	11.0
M16	34.5	30	11.0
M18	34.5	30	11.0

Channel End Cap

- Plastic,white or black

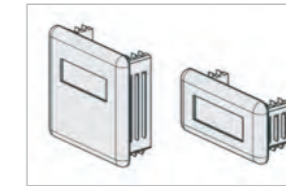

Cat.No.	Channel Size
EC-1	41x21
EC-2	41x41

Rod Coupling

- EG: Electro-Galvanized



Cat.No.	Thread Size
RC-M6	M6
RC-M8	M8
RC-M10	M10
RC-M12	M12
RC-M14	M14
RC-M16	M16
RC-M18	M18
RC-M20	M20

Drop In Anchor

- EG: Electro-Galvanized

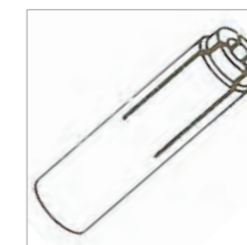

Cat.No.	Thread Size
DIA-M6	M6
DIA-M8	M8
DIA-M10	M10
DIA-M12	M12
DIA-M14	M14
DIA-M16	M16
DIA-M18	M18
DIA-M20	M20